



**APPLE ENGINEERING**

**BIM & CAD DESIGN SERVICES**



**COMPREHENSIVE BIM and CAD DESIGN SERVICES**

# COMPANY OVERVIEW

APPLE **ENGINEERING** is a multi-disciplined engineering company delivering advanced engineering services & solutions to the construction industry through innovative practices, utilizing BIM and advanced technological tools. With over a experience in the AEC industry, we have an impressive track record, successfully delivering a range of complex across multiple countries.

Our engineering team, with a workforce of more than 200 Engineers with Architectural, Structural and MEP experience, have the expertise and skillsets to meet the demands of any complex project anywhere in the world. We streamline our services to match & adapt to your constantly evolving needs.

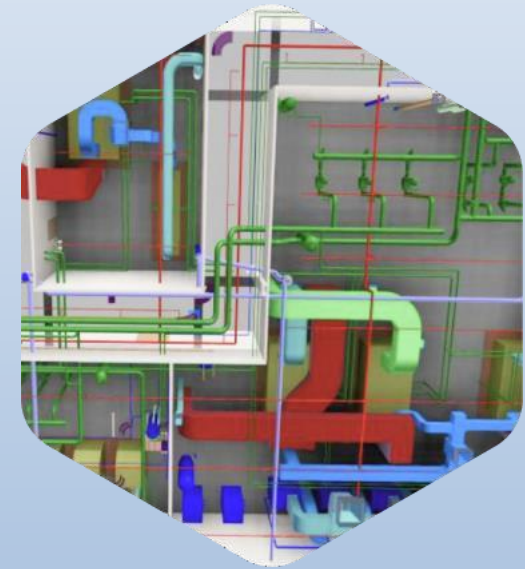

# OUR CLIENT BASE



# WHAT MAKES US UNIQUE

Development, management & streamlining of integrated multi-disciplinary performance models of projects & products



## Quality Standards

Fool proof QC & performance auditing based on customer feedback



## Global Operations

Sales Offices & operation in multiple countries



## Comprehensive Solutions

Comprehensive BIM and CAD services for architectural, structural, MEP trades under one umbrella



## End to End Service

Services that span the complete project project life cycle from design to maintenance



## Global Project Experience

Global track record across North America, Europe & Australasia



## Trade Knowledge & Expertise

Expert resources with multinational project experience & trade knowledge



# WHERE ARE WE NOW

Clients spanning across 17 countries with projects experience in over 4 continents

Multi-disciplinary engineering departments for Architecture, Mechanical, MEP, Façade, Precast, Steel & Rebar

Exceptional team of over 200 engineers with a diverse array of perspectives, talents, business experience and technical expertise

An umbrella of diverse services and solutions for all stages of a project from design through construction to facility management

Apple **Engineering** experience portfolio in residential, commercial, industrial, healthcare and educational projects

Around 4000 projects from over 700 clients



“

From humble beginnings, we have now grown to be one of most prominent global engineering services providers by setting the highest standards for our conduct and reputation in everything we do.

# OUR SERVICES

**ARCHITECTURAL BIM  
INTERIOR AND EXTERIOR DESIGN  
LANDSCAPE DESIGN & SHOP DRAWING**



**BIM OBJECT LIBRARIES**

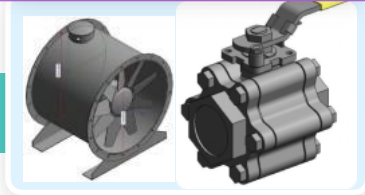

**COMPREHENSIVE BIM**



**FAÇADE DETAILING**



**INFRASTRUCTURE BIM**



**MEP BIM  
MEP COORDINATION**

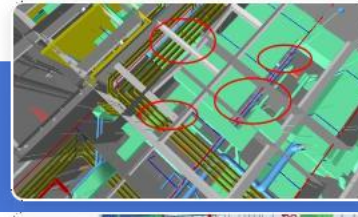

**PRECAST DETAILING**

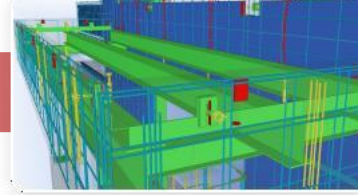

**STRUCTURAL DESIGN  
STRUCTURAL BIM  
REBAR DETAILING**

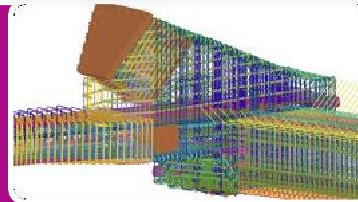

**SCAN TO BIM**



**STEEL DETAILING**

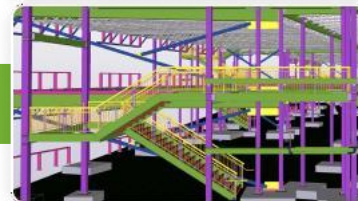

**BIM TRAINING**



# APPLE ENGINEERING IN BIM SUPPLY CHAIN

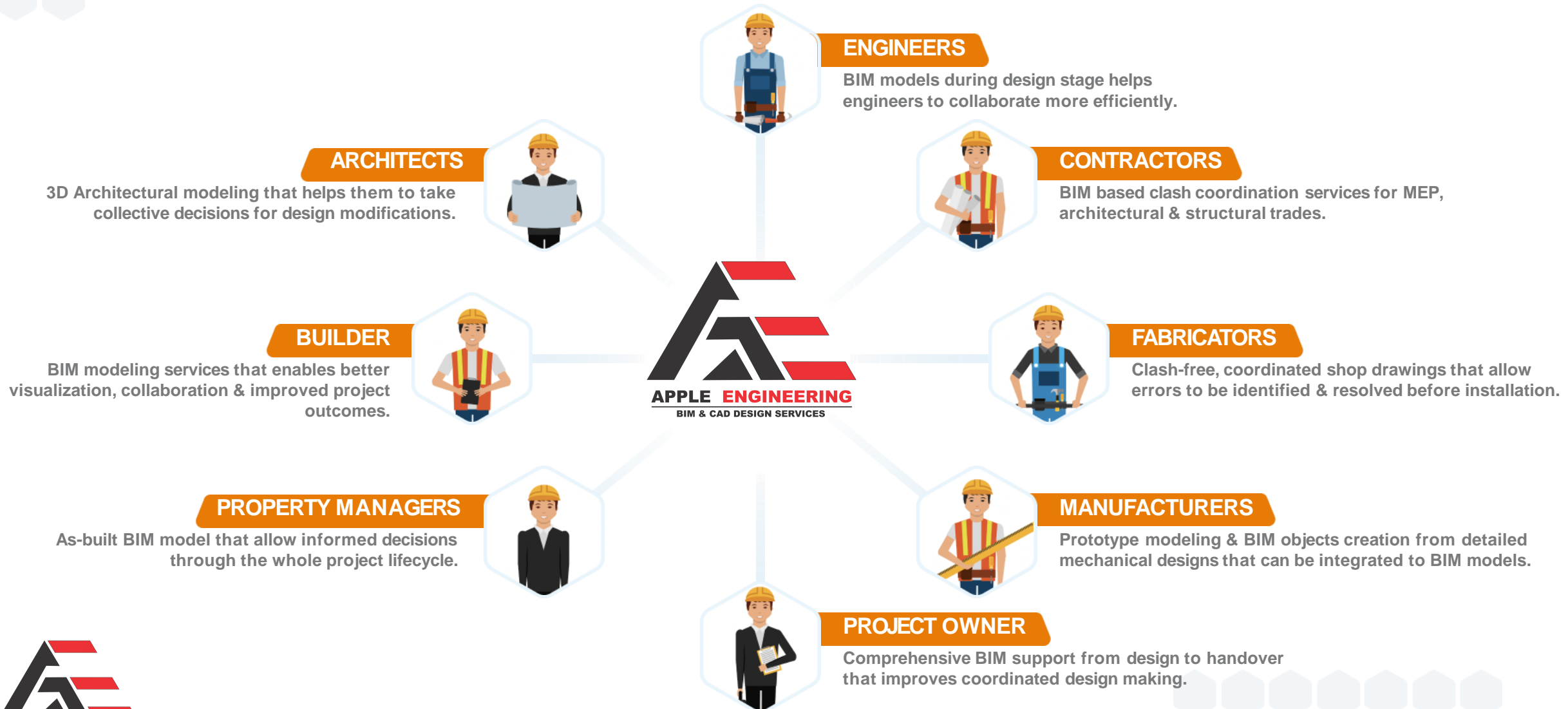

# ARCHITECTURAL MODELING

Intelligent visualization of projects with broad level of details and calculations to improve the quality of delivery and turnaround the time.

**ARCHITECTURAL BIM**

**SHOP DRAWING CREATION**

**DESIGN DEVELOPMENT**

**CONSTRUCTION DOCUMENTATION**

**POINT CLOUD MODELING**





# STRUCTURAL DESIGN ,STEEL, PRECAST & REBAR **DETAILING**

An established lineup of effective detailing services to ensure effective management of design and project constructability for reduced cost of installation and business growth.

**STRUCTURAL DESIGN**

**STEEL DETAILING**

**PRECAST DETAILING**

**REBAR DETAILING, BAR BENDING LIST**

**CONCRETE DETAILING**

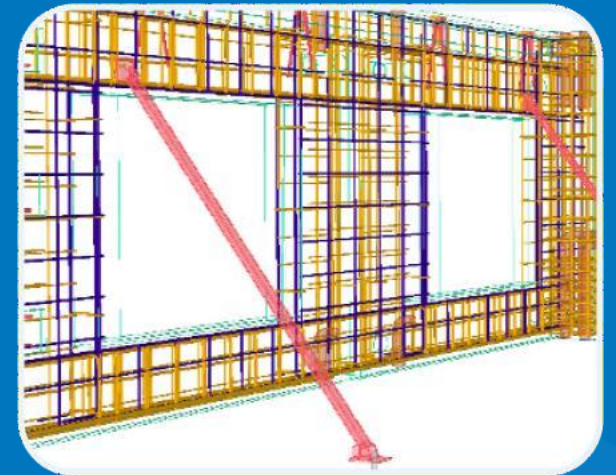
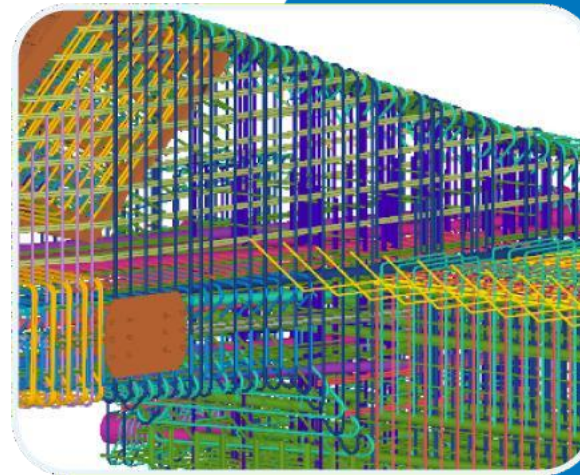
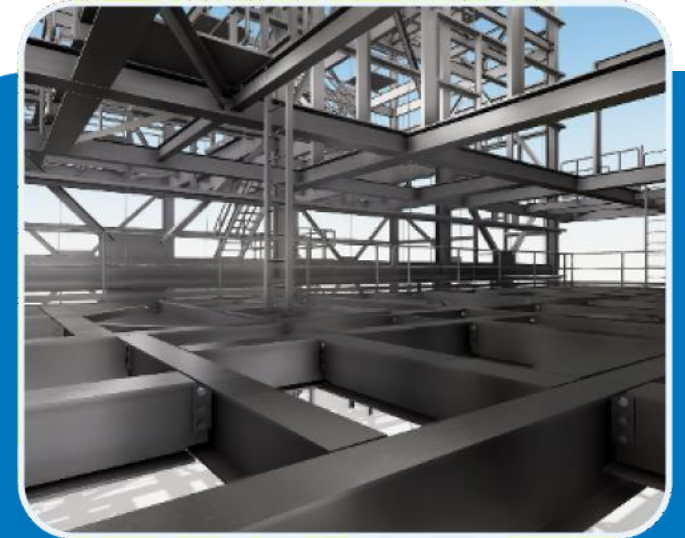
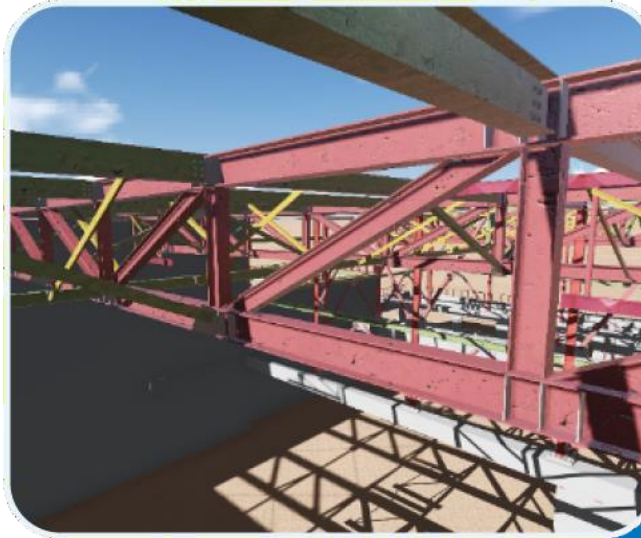

# FACADE ENGINEERING SERVICES

Accurate shop & fabrication drawings enabling clients to plan for optimized & balanced production of building envelope systems

**CURTAIN WALLS**

**SPIDER GLAZING**

**SHOP FRONTS & FRAMELESS GLASS**

**METAL PANELS & HAND RAILS**

**SKY LIGHTING & CANOPIES**

**WINDOWS, SLIDING/PARTITION DOORS**

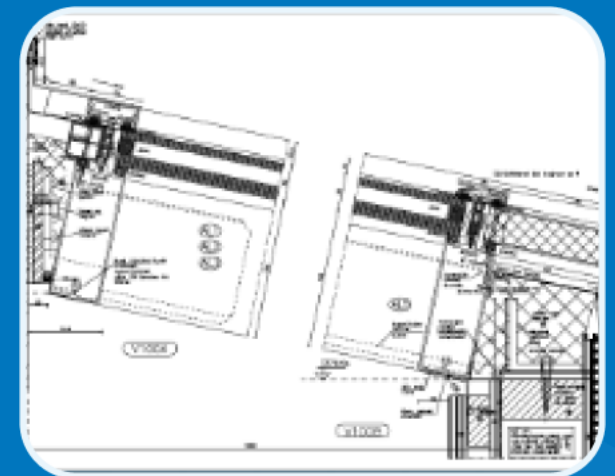
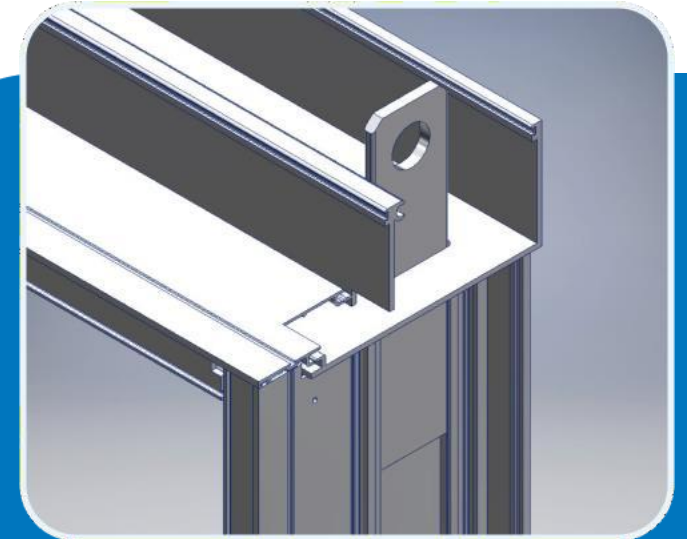
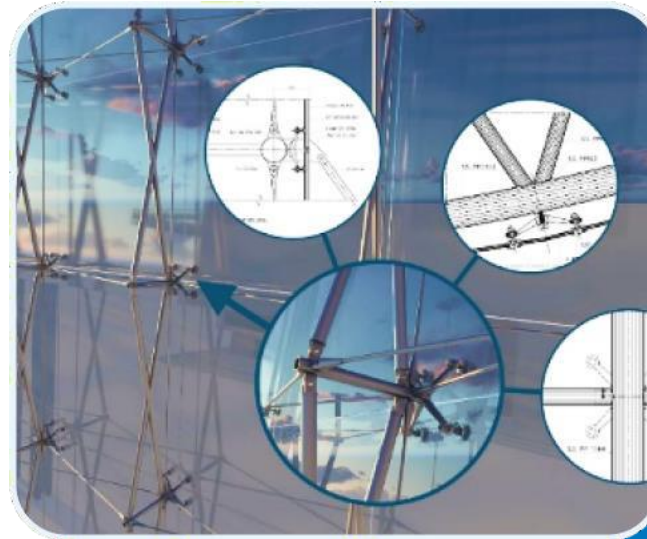

# CLASH DETECTION & RESOLUTION

Seamless coordination of MEP with Architecture & Structural trades, allowing all systems to work in perfect synchronization and at the same time maintaining the design intent

ARCHITECTURAL BIM

STRUCTURAL BIM

MEP BIM

RESOLUTION OF CLASHES

ONLINE COORDINATION MEETINGS

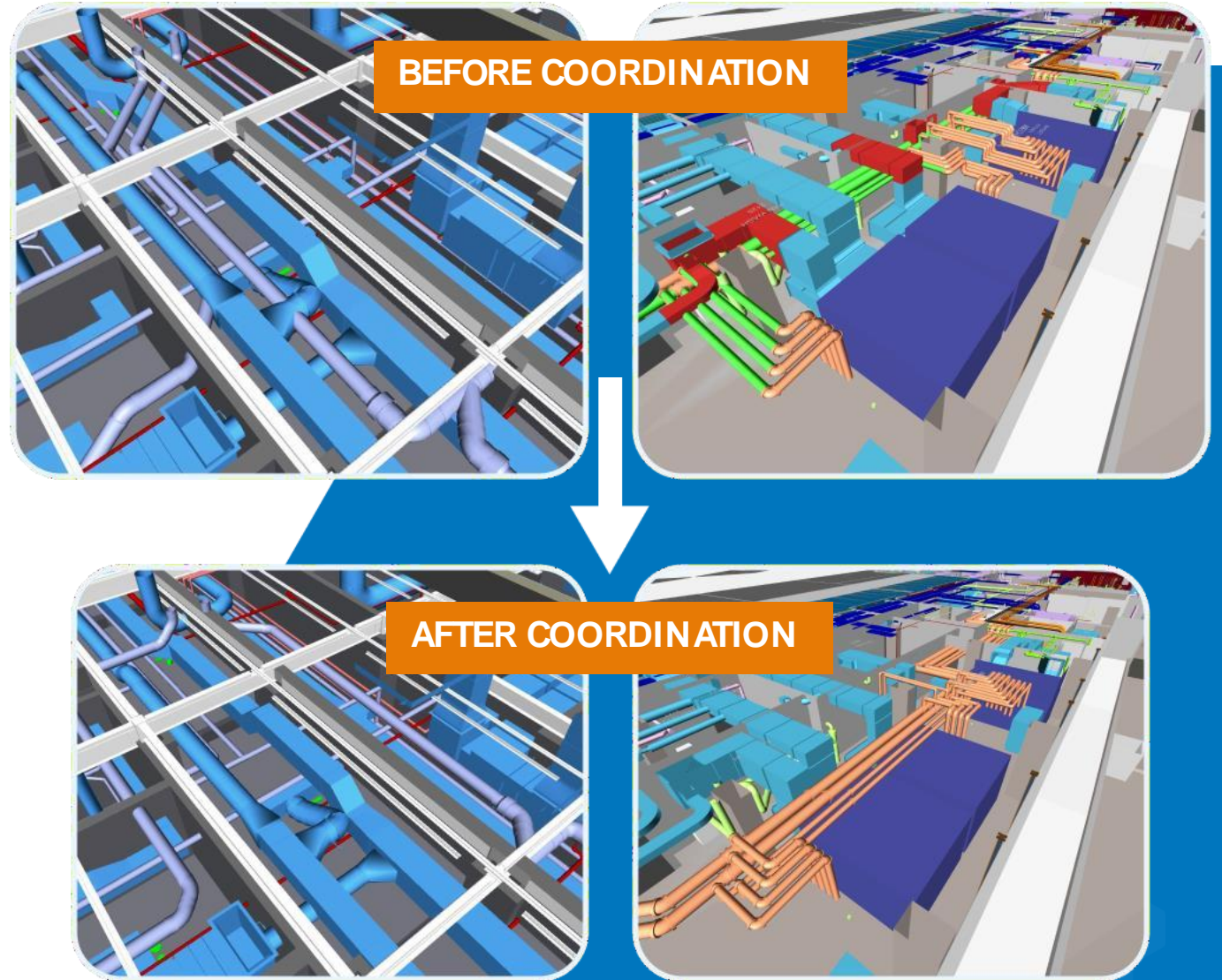

# INTEGRATED BIM PROJECT DELIVERY

Helping organizations leverage the potentials of BIM integrating architectural, structural, mechanical & plumbing systems

ARCHITECTURAL BIM

STRUCTURAL 3D MODELING

HVAC & PLUMBING MODELING

BIM CLASH COORDINATION

FABRICATION SHOP DRAWINGS

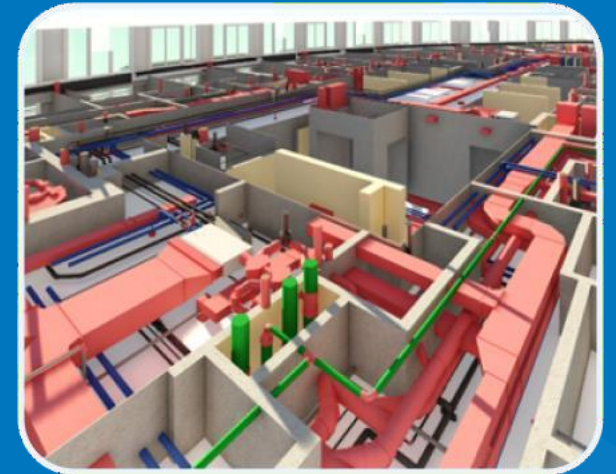
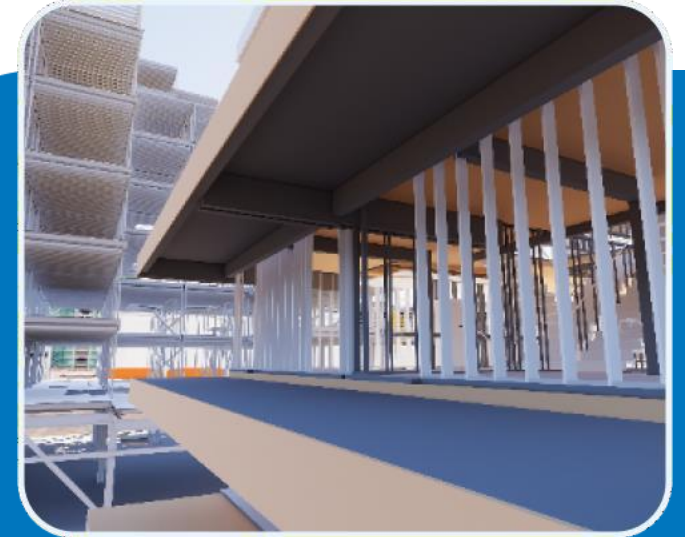
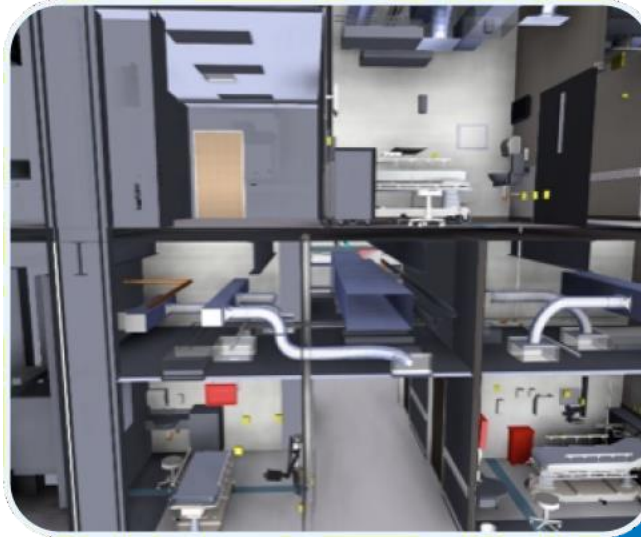

# INFRASTRUCTURE BIM

Integrated approach to model multi-disciplined trades for utility structures, power stations, water treatment plants, highways & bridges

**BRIDGE INFORMATION MODELING**

**BIM FOR WATER TREATMENT PLANTS**

**LANDSCAPE & SITE MODELING**

**TUNNEL INFORMATION MODELING**

**MARINE/OFFSHORE STRUCTURE MODELING**

**BIM FOR TRANSPORTATION**

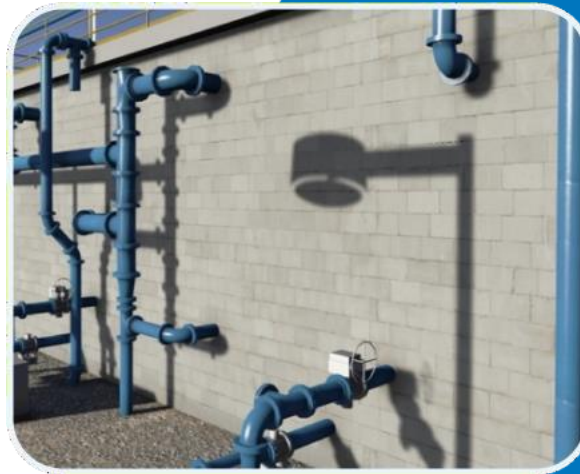
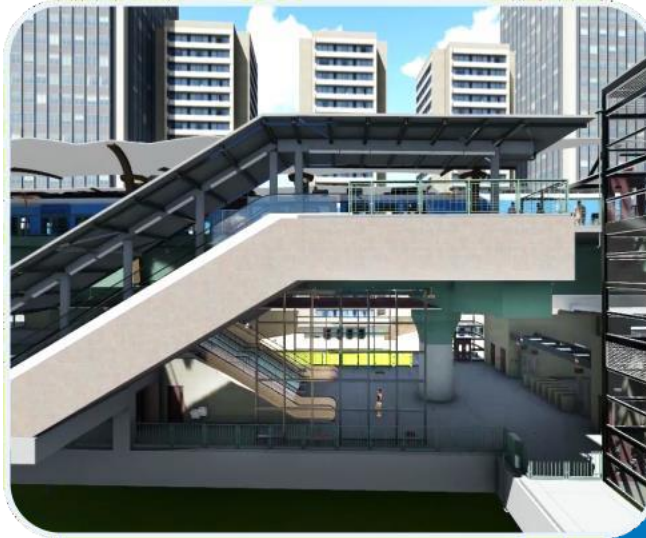

# INDUSTRIAL ENGINEERING

Our team create intelligent 3D models for site preparation, structural design and detailing, building design, piping and equipment layout. Enhance and integrate multidisciplinary collaboration and minimize data loss across your project.

**PROCESS PIPING DRAWINGS**

**BILL OF MATERIAL**

**ISOMETRIC DRAWINGS**

**P & ID DIAGRAMS**

**SCHEMATIC DRAWINGS**

**AS-BUILT DOCUMENTATION**

**COLLISION CHECKING**

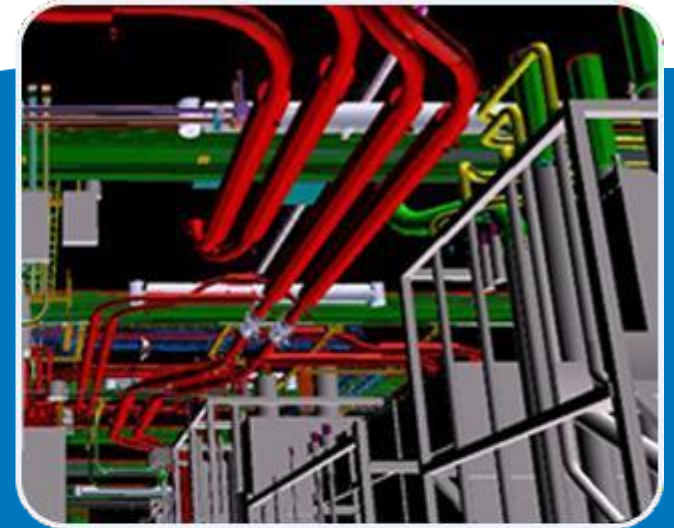

# MECHANICAL CAD/CAM

Our core expertise lies in providing 2D drafting & CAD 3D modeling services to clients for the fabrication & manufacturing of mechanical components.

SHOP DRAWINGS

FABRICATION DRAWINGS

ASSEMBLY DRAWINGS

SHEET METAL DRAWINGS

ISOMETRIC DRAWING

PARAMETRIC MODELING

3D SOLID MODELING

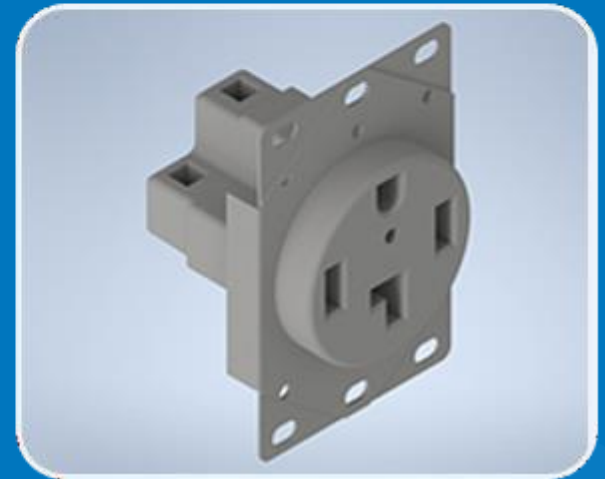
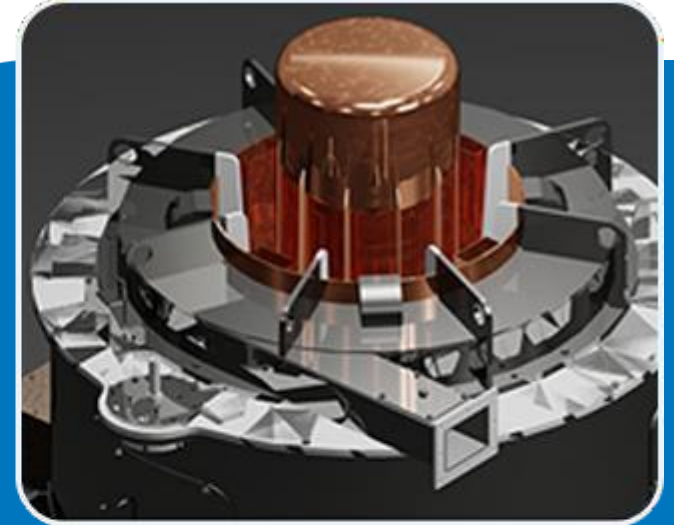
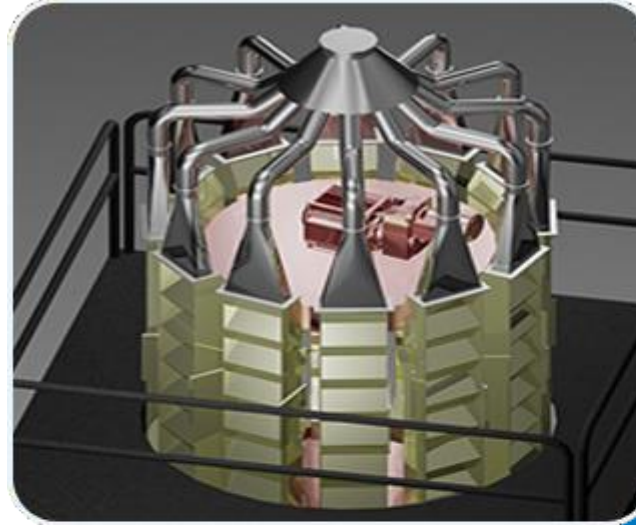

# POINTCLOUD SCAN TO BIM MODELING

The 3D BIM model that we create from laser scan data serve as accurate models for as-built purposes as well as for retrofit, refurbishment and renovation projects.

**ARCHITECTURAL CONVERSION**

**STRUCTURAL CONVERSION**

**MEP CONVERSION**





# REVIT FAMILY CREATION

Creation of standard and customized revit families for the retail, manufacturing and the construction industry from the manufacturer's submittals or even hand sketches.

ARCHITECTURAL ELEMENTS

STRUCTURAL COMPONENTS

MECHANICAL FITTINGS

PLUMBING FIXTURES

PRODUCT LIBRARIES

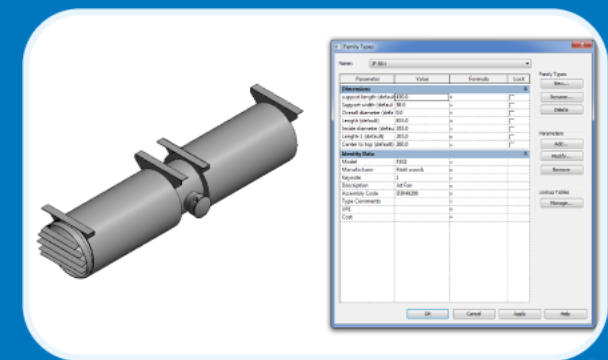
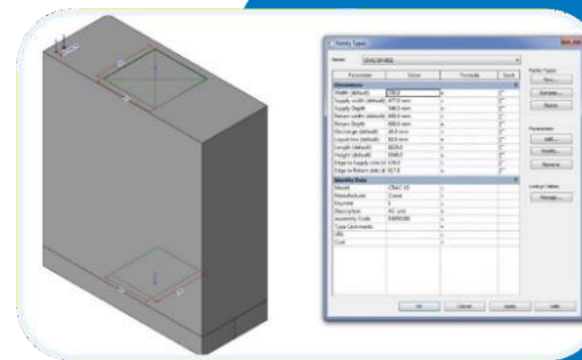
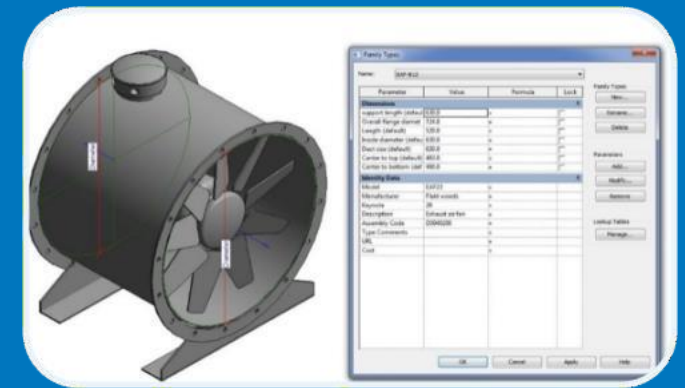
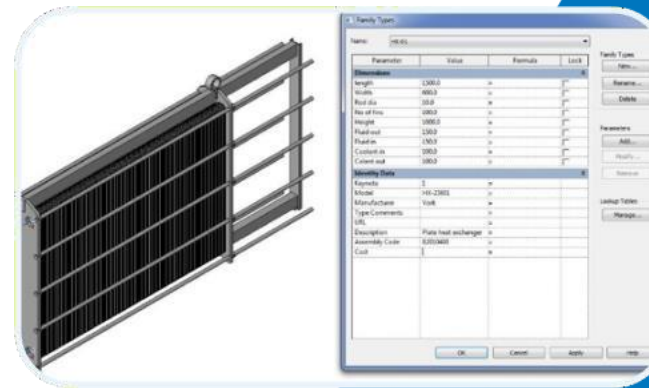

# BIM CONSULTING SERVICES

we have been assisting construction companies, general & specialty contractors in their migration to BIM from CAD. We act as a strategic BIM partner to the client educating and training them for seamless migration from CAD drafting to BIM implementation.

**BIM MODEL AUDIT**

**OFFSHORE BIM TEAM**

**BIM IMPLEMENTATION PLANNING**

**BIM TRAINING**

**ON-SITE BIM SUPPORT**

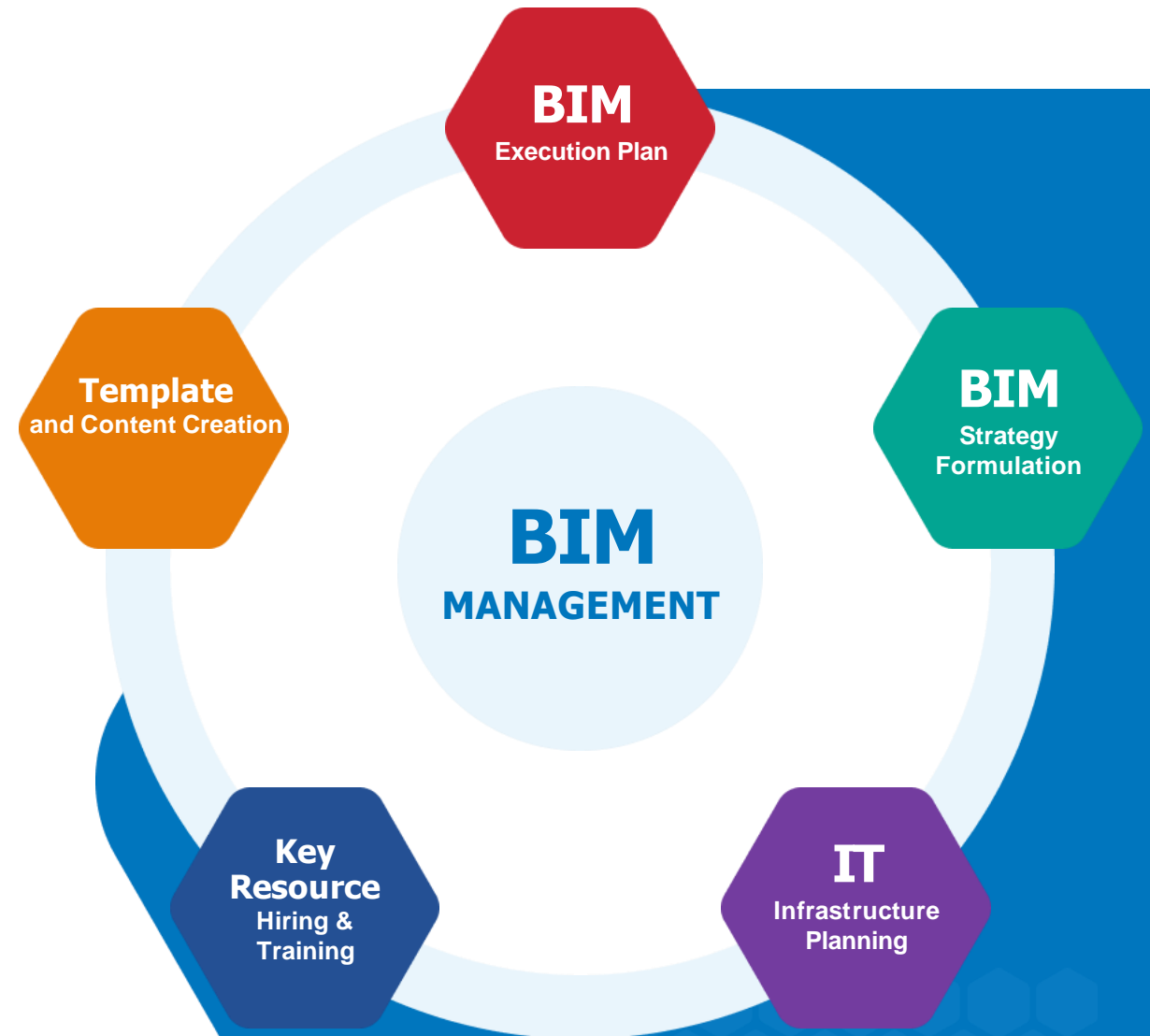
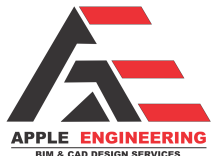

# TEAM PROFICIENCY AND SOFTWARE PROFICIENCY

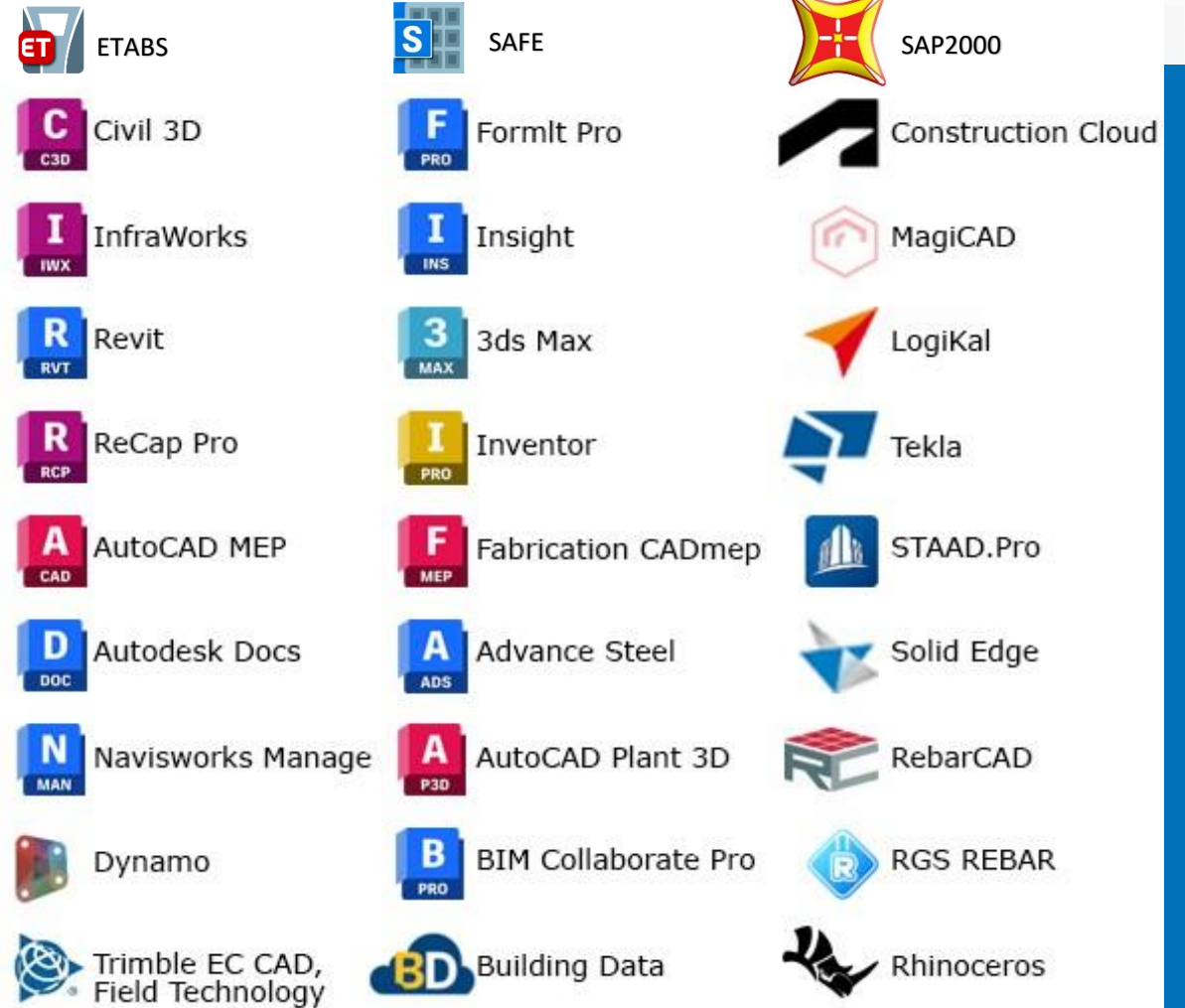
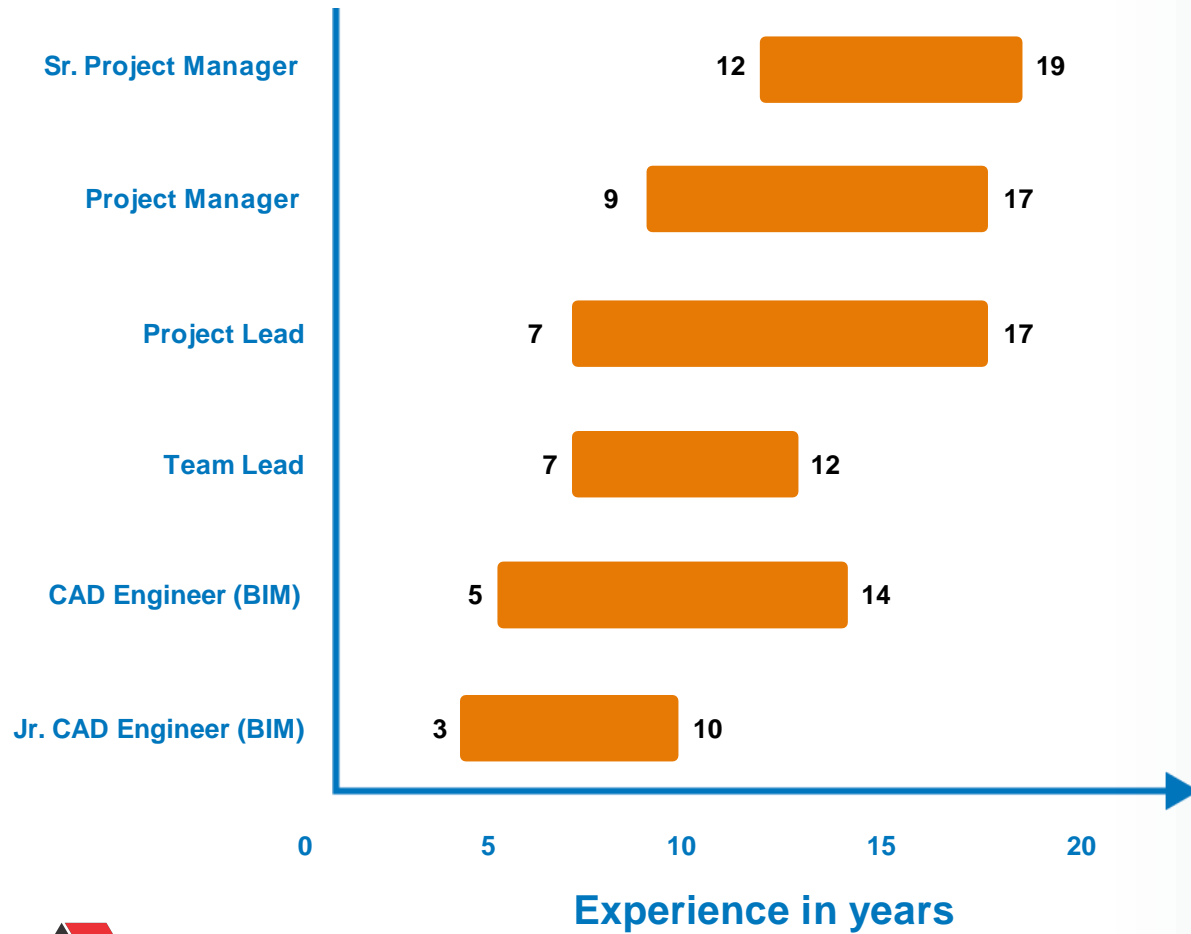

# CONTACT US

---



**APPLE ENGINEERING .**

Dubai , United Arab Emirates

Phone: +971-567362939





**THANK YOU**



**APPLE ENGINEERING**

**BIM & CAD DESIGN SERVICES**

